

SCALE: 1/2

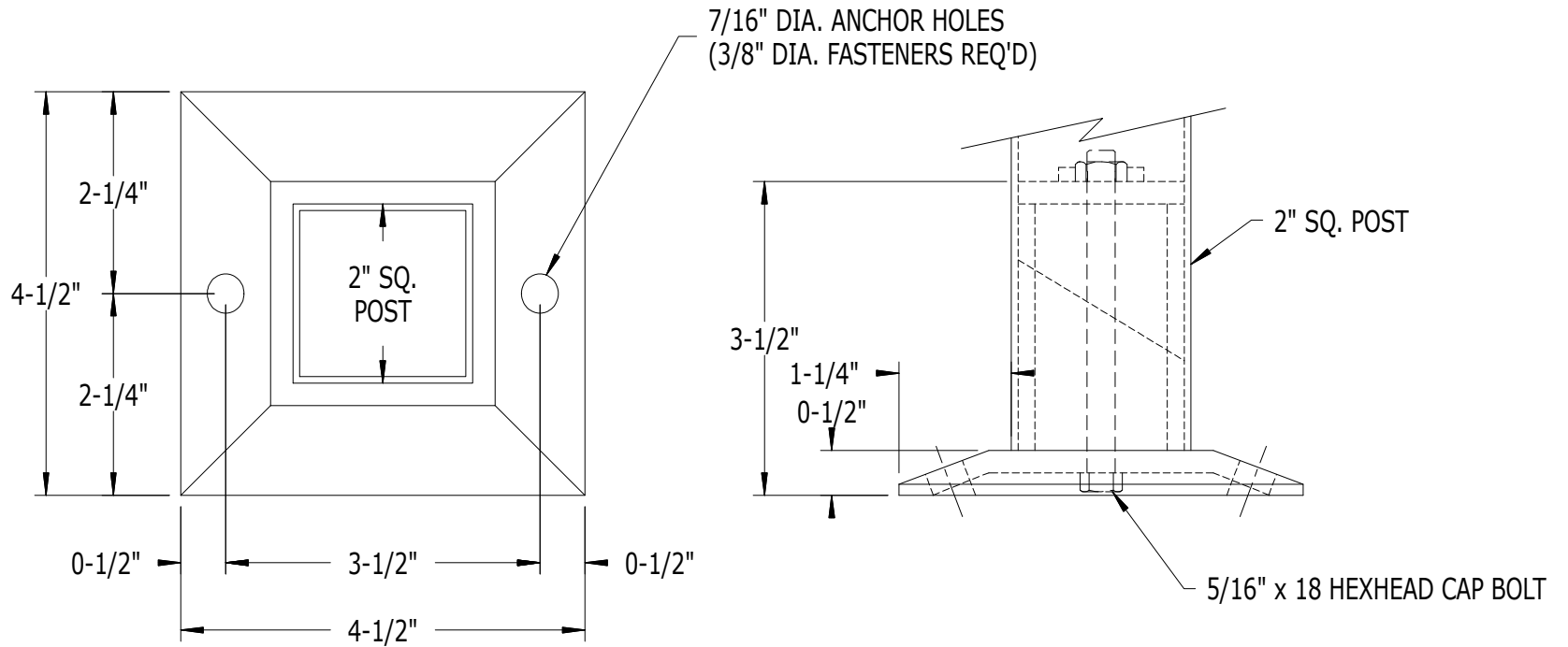

PART NO.

DESCRIPTION

968

WEDGE BASE FOR 2" SQ. POST

SUPERIOR
ALUMINUM PRODUCTS