

SCALE: 1/1

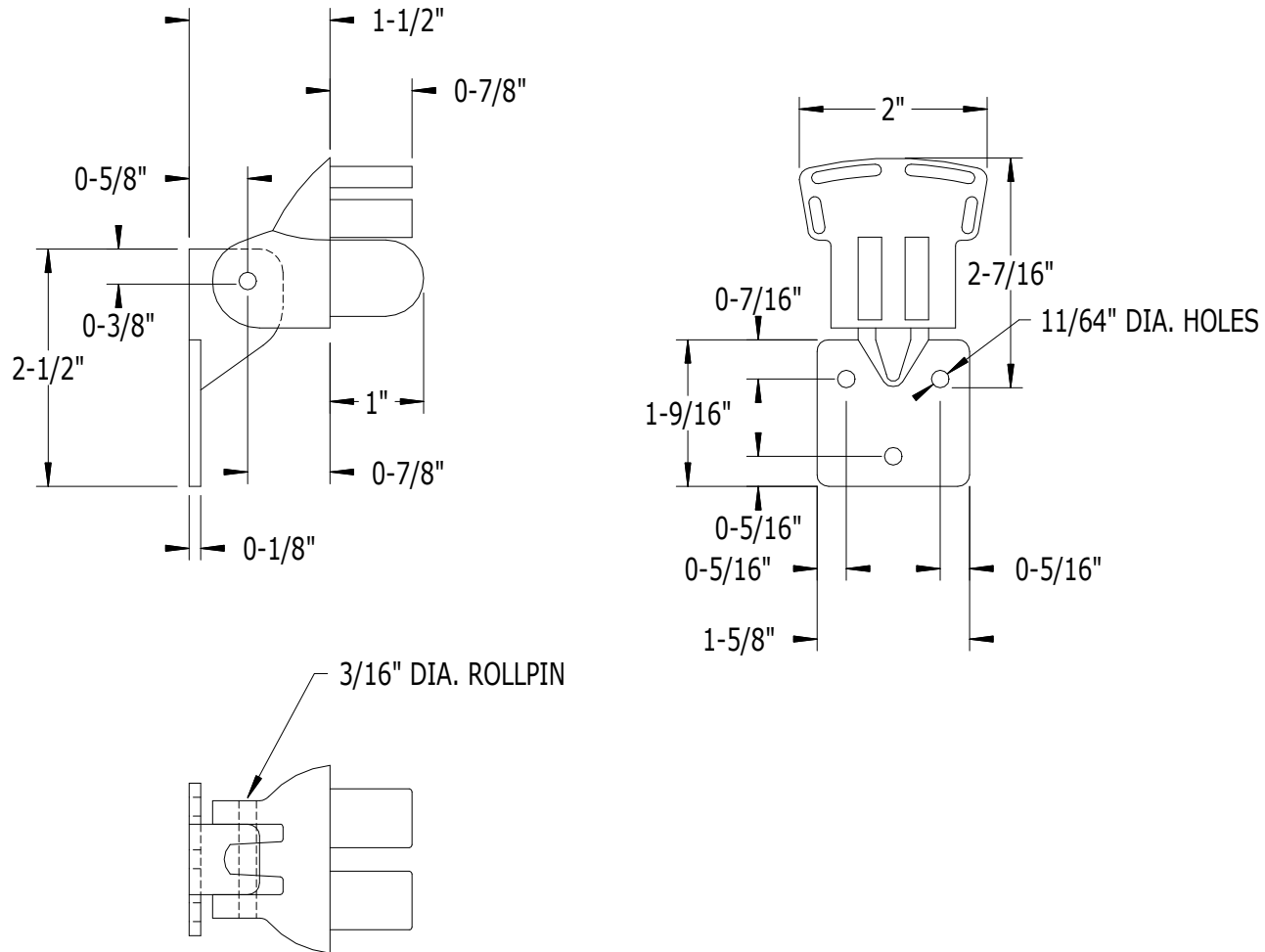

PART NO.

DESCRIPTION

9059

VERTICAL SWIVEL BRACKET
FOR #9005 TOP RAIL

SUPERIOR
ALUMINUM PRODUCTS